

# FASTENERS

A collection of various metal fasteners including bolts, nuts, washers, and a hook, scattered on a light surface. The fasteners are arranged in a way that shows different types and sizes, with some in the foreground and others in the background. The lighting is bright, highlighting the metallic texture and the threads of the bolts and nuts.

2026/27



KOVIAN, s.r.o. is a family-owned company founded by four brothers with a vision to build a stable and reliable business based on strong family values. Thanks to their shared dedication and determination, the company has been offering high-quality forged semi-finished products and components for blacksmiths and metalworkers for over 17 years. Their goal was to provide reliable solutions and expert advice while continuously striving to be as close to their customers as possible. They have succeeded in this — also thanks to their own delivery service across Slovakia and the Czech Republic. KOVIAN is a great example of a successful family business that continues to grow and innovate.



KOVIAN, s.r.o. ist ein Familienunternehmen, das von vier Brüdern mit der Vision gegründet wurde, ein stabiles und zuverlässiges Unternehmen auf soliden familiären Werten aufzubauen. Dank ihres gemeinsamen Engagements und ihrer Entschlossenheit bietet das Unternehmen seit über 17 Jahren hochwertige Schmiedevorprodukte und Komponenten für Schmiede und Schlosser an. Ihr Ziel war es, zuverlässige Lösungen und fachkundige Beratung bereitzustellen und den Kunden stets so nahe wie möglich zu sein. Dies ist ihnen auch gelungen – unter anderem dank ihres eigenen Lieferservices in der Slowakei und in der Tschechischen Republik. KOVIAN ist ein Beispiel für ein erfolgreiches Familienunternehmen, das weiterhin wächst und Innovationen hervorbringt.



KOVIAN, s.r.o. je rodinná firma, ktorú založili štyria bratia s víziou vybudovať stabilný a spoľahlivý podnik postavený na pevných rodinných hodnotách. Vďaka ich spoločnému úsiliu a odhodlaniu firma už viac ako 17 rokov ponúka kvalitné kované polotovary a komponenty pre kováčov a zámočníkov. Ich cieľom bolo poskytovať spoľahlivé riešenia a odborné poradenstvo, pričom sa neustále snažili byť čo najbližšie k zákazníkom. To sa im aj podarilo – aj vďaka vlastnému rozvozu po Slovenskej a Českej republike. KOVIAN je príkladom úspešného rodinného podnikania, ktoré naďalej rastie a prináša inovácie.



KOVIAN, s.r.o. je rodinná firma, kterou založili čtyři bratři s vizí vybudovat stabilní a spolehlivý podnik postavený na pevných rodinných hodnotách. Díky jejich společnému úsilí a odhodlání firma již více než 17 let nabízí kvalitní kované polotovary a komponenty pro kováře a zámečníky. Jejich cílem bylo poskytovat spolehlivá řešení a odborné poradenství, přičemž se neustále snažili být co nejbližší zákazníkům. To se jim také podařilo – i díky vlastní rozvážkové službě po České a Slovenské republice. KOVIAN je příkladem úspěšného rodinného podnikání, které naďale roste a přináší inovace.

**KOVIAN, S.R.O.**  
**ŠPORTOVÁ 749**  
**900 61 GAJARY, SLOVAKIA**



*Find your nearest dealer*

**DEALER MAP | HÄNDLERKARTE | MAPA PREDAJCOV | MAPA PRODEJČŮ**

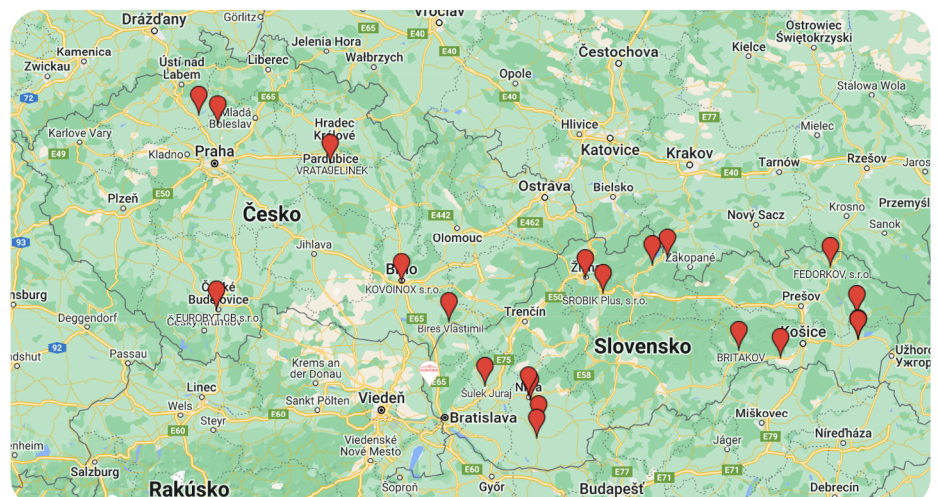

# CONTENT

 **FASTENERS**

 **VERBINDUNGSMATERIAL**

 **SPOJOVACÍ MATERIÁL**

 **SPOJOVACÍ MATERIÁL**

**Stainless steel fasteners** 6

Befestigungselemente aus Edelstahl

Nerezový spojovací materiál

Nerezový spojovací materiál

**Light load anchors** 12

Dübel

Hmoždinky

Hmoždinky

**Anchors** 16

Anker

Kotvy

Kotvy

**Self- tapping screws** 18

Selbstschneidende Schrauben

Samorezné skrutky

samořezné vruty

**Screw and nut caps & leveling feet** 22

Abdeckkappen für Schrauben und Muttern

und Stellfüße

Krytky na skrutky a matice a Nivelačné nohy

Krytky na šrouby a matice a Nivelační nožičky

**Metric screws & threaded rods** 24

Metrische Schrauben und Gewindestangen

Metrické skrutky a Závitové tyče

Metrické šrouby a Závitové tyče

**Nuts** 25

Muttern

Matice

Matice

**Rivets & Accessories** 26

Nieten und Zubehör

Níty a Příslušenstvo

Nýty a Příslušenství

**Washers** 28

Unterlegscheiben

Podložky

Podložky

<b>Fence anchoring</b>	29
Zaunbefestigung	
Kotvenie oplotenia	
Kotvení oplocení	
<b>Chemical anchors &amp; Accessories</b>	30
Chemische Verankerungen und Zubehör	
Chemické kotvenie a Príslušenstvo	
Chemické kotvenia a Príslušenství	
<b>Accessories for mounting C-profiles</b>	32
Zubehör für Montage-C-Profil	
Príslušenstvo k montážnym C profilom	
Příslušenství k montážním C profilům	
<b>Ground screws</b>	34
Erdschrauben	
Zemné vruty	
Zemní vruty	
<b>Wood connectors</b>	36
Befestigungselemente für Zimmereien	
Tesařské prvky	
Tesařské prvky	
<b>Decorative rivets, nails, screws, nuts</b>	38
Ziernieten, Nägel, Schrauben, Muttern	
Dekoračné nity, klince, skrutky, matice	
Dekorační nýty, hřebíky, šrouby, matky	
<b>Welding wire</b>	40
Schweißdraht	
Zváracie drôty	
Svařovací dráty	





**AISI304** Most frequently used steel, resistant to rust. Usable in both exterior and interior applications. Not recommended for use in aggressive environments such as seawater or swimming pools.

Die am häufigsten verwendete Stahlart, korrosionsbeständig. Geeignet für Innen- und Außenbereiche – nicht empfohlen für den Einsatz in aggressiveren Umgebungen wie Meerwasser, Schwimmbäder usw.

Najpoužívanejšia oceľ, odolná voči korózií. Vhodná pre interiér aj exteriér – neodporúča sa pri použití v agresívnejších prostrediach – morská voda, bazény atď.

Nejpoužívanější ocel, odolná vůči korozi. Vhodná pro interiér i exteriér – nedoporučuje se pro použití v agresivnějším prostředí – mořská voda, bazény atd.

**AISI316** Stainless steel with increased resistance to corrosion and acids. It is used in environments with high concentrations of chlorine, salts, in chemical laboratories, swimming pools, and is also resistant to seawater.

Edelstahl mit erhöhter Korrosions- und Säurebeständigkeit. Wird in Umgebungen mit hoher Konzentration von Chlor, Salzen, in chemischen Laboratorien, Schwimmbädern verwendet und ist auch beständig gegen Meerwasser.

Nerezová oceľ so zvýšenou odolnosťou proti korózii a kyselinám. Používa sa v prostredí s vysokou koncentráciou chlóru, solí, v chemických laboratóriách, plaveckých bazénoch, odoláva aj morskej vode.

Nerezová ocel se zvýšenou odolností proti korozi a kyselinám. Používá se v prostředí s vysokou koncentrací chloru, solí, v chemických laboratořích, plaveckých bazénech, odolává i mořské vodě.

**AISI 316L** Stainless steel with high corrosion resistance. Thanks to molybdenum, it withstands saltwater and chemicals. L = low carbon, so no corrosion cracking occurs during welding.

Edelstahl mit hoher Korrosionsbeständigkeit. Durch den Molybdänanteil hält er Salzwasser und Chemikalien stand. L = niedriger Kohlenstoffgehalt, daher entstehen beim Schweißen keine Korrosionsrisse.

Nerezová oceľ s vysokou odolnosťou proti korózii. Vďaka molybdénu vydrží slanú vodu aj chemikálie. L = nízky uhlík, takže pri zváraní nevznikajú korózne trhliny.

Nerezová ocel s vysokou odolností proti korozi. Díky molybdenu vydrží slanou vodu i chemikálie. L = nízký obsah uhlíku, takže při svařování nevznikají korozní trhliny.

**AISI 308L** Welding stainless steel for 304 and 304L steels. L = low carbon, so no corrosion cracking occurs during welding.

Schweiß-Edelstahl für die Stähle 304 und 304L.

L = niedriger Kohlenstoffgehalt, daher entstehen beim Schweißen keine Korrosionsrisse.

Zváracia nerez pre ocele 304 a 304L.

L = nízký uhlík, takže pri zváraní nevznikajú korózne trhliny.

Svařovací nerez pro oceli 304 a 304L.

L = nízký obsah uhlíku, takže při svařování nevznikají korozní trhliny.

**PLASTIC** PLACTIC/KUNSTSTOFF/PLAST

**Zn** GALVANIZED/VERZINKT/POZINKOVANÁ

**ALU** ALUMINIUM/HLINÍK

**RUBBER** RUBBER/GUMMI/GUMA

**RAW** WITHOUT SURFACE TREATMENT/OHNE BEARBEITUNG/BEZ ÚPRAVY

**RAL9005** COLOR RAL9005/FARBE RAL9005/FARBA RAL9005/BARVA RAL9005

**PH** PHOSPHATE/PHOSPHAT/FOSFÁT

**Zn** YELLOW GALVANIZED/GELB VERZINKT/ŽLTÝ POZINK/ŽLUTÝ POZINK

**Ni** NICKEL/NICKEL/NIKEL/NIKL

**G3Si1/SG2** UNIVERSAL MIG/MAG WELDING WIRE FOR UNALLOYED STEELS /UNIVERSELLER MIG/MAG-SCHWEISSDRAHT FÜR UNLEGIERTE STÄHLE/UNIVERZÁLNY MIG/MAG ZVÁRACÍ DRÔT PRE NELEGOVANÉ OCELE/UNIVERZÁLNI MIG/MAG SVAŘOVACÍ DRÁT PRO NELEGOVANÉ OCELI

**FLUX core** SELF SHIELDED WIRE/SELBSTSCHÜTZENDER SCHWEISSDRAHT/TRUBIČKOVÝ ZVÁRACÍ DRÔT/TRUBIČKOVÝ SVAŘOVACÍ DRÁT

**PA** POLYAMIDE-NYLON/POLYAMID-NYLON

**STEEL** STEEL/STAHL/OCEĽ/OCEL

**HDG** HOT-DIP GALVANIZED/FEUERVERZINKUNG/ŽIAROVÝ POZINK/ŽÁROVÝ POZINK

**BRASS** BRASS/MESSING/MOSADZ/ MOSAZ

**ALLOY** ALLOY/LEGIERUNG/ZLIATINA/SLITINA

**RAL7016** COLOR RAL7016/FARBE RAL7016/FARBA RAL7016/BARVA RAL7016

**EPDM** RUBBER RESISTANT TO UV RADIATION, OZONE, WATER AND EXTREME TEMPERATURES/GUMMI, DER GEGEN UV-STRAHLUNG, OZON, WASSER UND EXTREME TEMPERATUREN BESTÄNDIG IST/GUMA ODOLNÁ VOČI UV ŽIARENÍU, OZÓNU, VODE AJ EXTRÉMNYM TEPLOTÁM /GUMA ODOLNÁ VŮČI UV ŽÁŘENÍ, OZONU, VODĚ I EXTRÉMNÍM TEPLOTÁM

**E6013** WELDING ELECTRODE E6013/SCHWEISSELEKTRODE E6013/ZVÁRACIA ELEKTRODA E6013/SVAŘOVACÍ ELEKTRODA E6013



## NUTS



**E1M E2M**

AISI304 AISI316



**E1EM E2EM**

AISI304 AISI316



**E1PM**

AISI304



**E1DIN6923**

AISI304



**E1DIN6926**

AISI304



**E1OM E2OM**

AISI304 AISI316



**E1NUM**

AISI304



**E1BM E2BM**

AISI304 AISI316



**E1DM**

AISI304



**E1TM**

AISI304



**E1ZM**

AISI304



**E1ZVM**

AISI304



**E1MVK**

AISI304



**E1OKO**

AISI304



**E1-PLAM**

AISI304



**E1DIN537**

AISI304

## METRIC SCREWS



**E15M E25M**

AISI304 AISI316



**E12M E22M**

AISI304 AISI316



**E11M E21M**

AISI304 AISI316



**E17M**

AISI304



**E19M E29M**

AISI304 AISI316



**E1CM**

AISI304



**EB1-LOM**

AISI304



**T-SR**

AISI304

## WASHERS



**E1PO**

AISI304



**E1POV**

AISI304



**E1-P1458**

AISI304



**E1PE**

AISI301



**E1-BP8**

AISI304



**E1VP**

AISI304

## TAPPING SCREWS



**E1-3S4.2X19X**

AISI304



**E1-3S6.3X22X**

AISI304



**E1-4S4.2X19X**

AISI304



**E1-5931**

AISI304



# stainless steel fasteners

## SCREWS



**E1-TS**

AISI304



**E1-TS+ E2-TS+**

AISI304 AISI316



**E10705**

AISI304



**E10706**

AISI304



**E10707**

AISI304



**E13S E23S**

AISI304 AISI316



**E13S3.5**

AISI304



**E14S E24S**

AISI304 AISI316



**E14S3.5**

AISI304



**E1STK**

AISI304



**E2-4ST10x120**

AISI316

## THREADED RODS & BOLTS



**E1ZT E2ZT**

AISI304 AISI316



**E1SVM**

AISI304



**E1-ZK14-10**

AISI304

## ANCHORS



**E1KP**

AISI304



**E2BS**

AISI316



**E1-ATS12x120**

AISI304



**E1-ATSS12x85**

AISI304



**E1-NWOX2**

AISI304



**QUICK-FIX**

AISI304

**SELF-DRILLING & COMBINED SCREWS**



**BI-METAL**

BI-METAL



**EITEK**

AISI304



**E1DIN7504MX**

AISI304



**E1DIN7504MZ**

AISI304



**E1DIN7504OX**

AISI304



**E1HB**

AISI304



**E1SM**

AISI304

**STAINLESS STEEL RIVETS**



**E1NM**

AISI304



**E1NLM**

AISI304



**E1NRM**

AISI304



**E1NT**

AISI304



**E1-FH-FHB**

AISI304



**E1-RH-FHB**

AISI304



**E1NS**

AISI304



## STAINLESS STEEL PINS



**E1-KS1**

AISI304



**DIN1473**

AISI303

## ACCESSORIES FOR CHAINS & ROPES



**E2-8160**

AISI316



**E2-8247**

AISI316



**E2-8248**

AISI316



**E2-8249**

AISI316



**E2-8250**

AISI316



**E2-8253**

AISI316



**E2-8254**

AISI316



**E2-8255**

AISI316



**E2-8256**

AISI316



**E2-8258**

AISI316



**E2-8259**

AISI316



**E2-8260**

AISI316



**E2-8267**

AISI316



**E2-8268**

AISI316



**E2-8362**

AISI316



**EB1-LS**

AISI304



**EB1-LSD**

AISI304



**EB1-OLU**

AISI304



**EB1-OP**

AISI304



**EB1-ULND**

AISI304



**EB1-ULO**

AISI304



**EBINX**

AISI304



**E1OKOS**

AISI304



**E2-8229**

AISI316

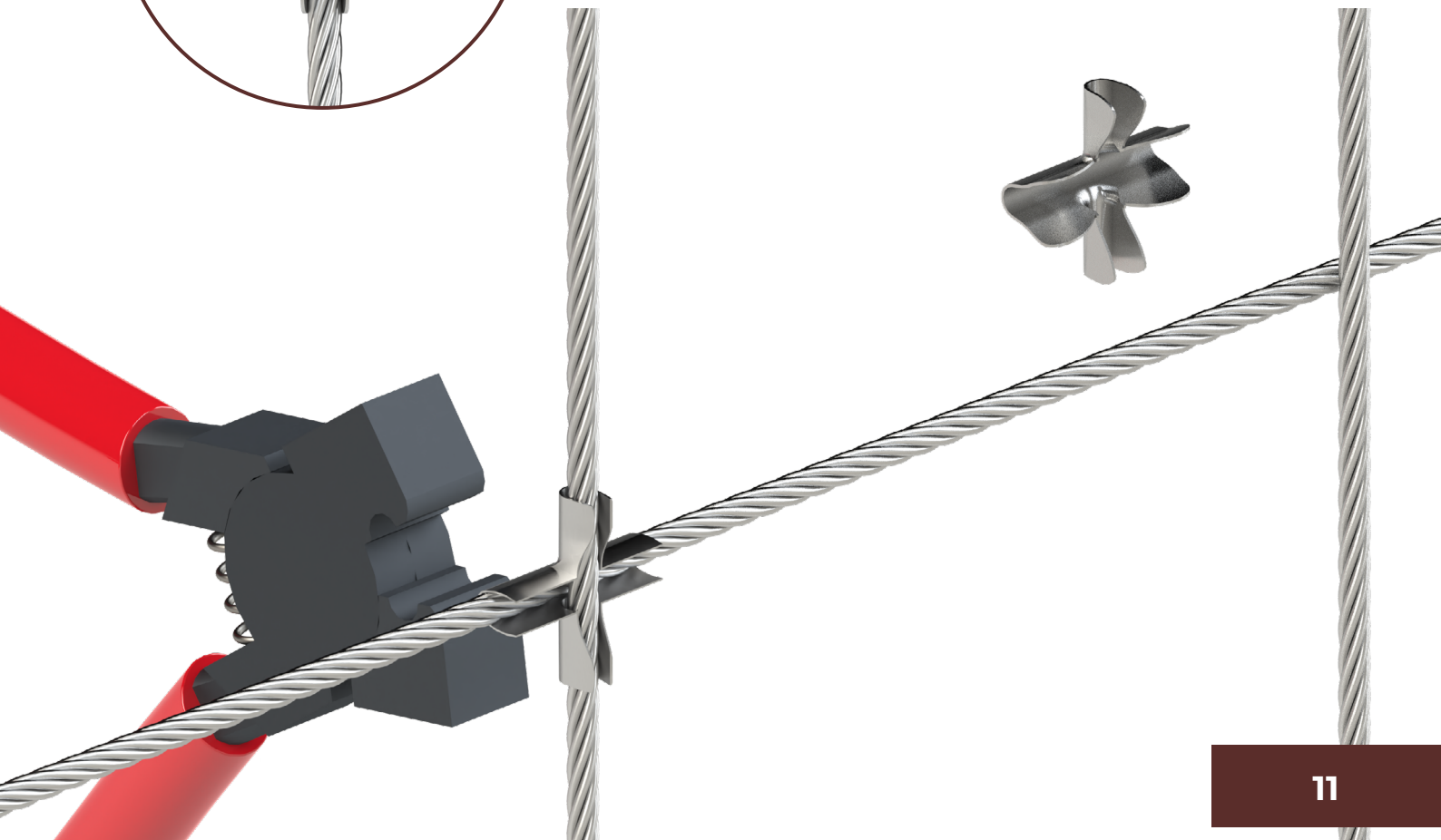
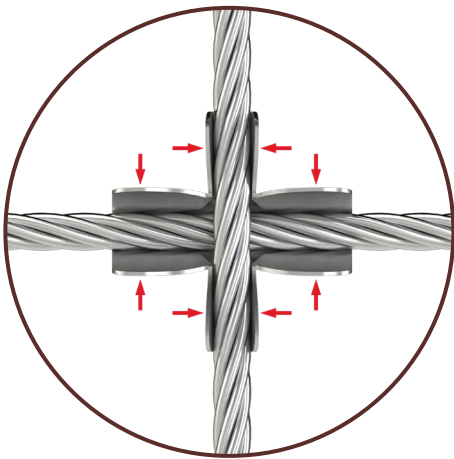



# Light load anchors



**SFXU**

PA



**DUOPOWER**

PA



**KPW**

PA



**GKK**

PLASTIC



**KPRBS**

PLASTIC



**KPRHR**

PLASTIC



**KPU**

PA



**BOGE**

PLASTIC



**KPX**

PLASTIC



**DRN-23**

PLASTIC



**WKDS**

PLASTIC



**DRZN-29**

Zn



**FGD**

PA



**KMGPB**

Zn



**TABM**

Zn





**GKW**

Zn

PLASTIC



**KPRPSK**

Zn

PLASTIC



**KPS08**

Zn

PLASTIC



**KPSIX**

Zn

PLASTIC



**KPS6HR**

Zn

PLASTIC



**KRX**

Zn

PLASTIC



**KWPZ**

Zn

PLASTIC



**RUPZ**

Zn

PLASTIC



**SFXP**

Zn

PA



**SMHN**

Zn

PLASTIC



**SMKHN**

Zn

PLASTIC



**SMKCHN**

Zn

PLASTIC



**MOLLY**

Zn



**DUOXPAND**

Zn

PA



**HybridPower 10x90**

Zn

PA



**KPK12**

Zn

PLASTIC



**KPRFAST**

Zn

PLASTIC



**KPRPK**

Zn

PLASTIC



**KPS6HR**

Zn

PLASTIC



**SFXK**

Zn

PA



# Light load anchors



**RUC**

Zn

PLASTIC



**SFXC**

Zn

PA



**WXUNI**

Zn

PLASTIC



**MHS-04032**

Zn



**PXUNI**

Zn

PLASTIC



**RUL**

Zn

PLASTIC



**SFXL**

Zn

PA



**HOXUNI**

Zn

PLASTIC



**HX-12**

Zn

PLASTIC



**RUO**

Zn

PLASTIC



**SFXO**

Zn

PA



**FIXTAINER DUOPOWER**

PA



**RED BOX DUOPOWER**

PA







**HT-1**



**KDR**



Master	Concrete 	Aerated concrete 	Brick 	Plasterboard 	Polystyrene 
BOGE	✓	✓	✓		
DRN-23				✓	
DUOPOWER	✓	✓	✓	✓	
GKK				✓	
KPRBS	✓	✓	✓		
KPRHR	✓	✓	✓		
KPU	✓		✓	✓	
KPW	✓	✓	✓	✓	
KPX	✓	✓	✓		
SFXU	✓	✓	✓	✓	
Wkds					✓
DRZN-29				✓	
FGD	✓				
KMGPB		✓			
TABM	✓	✓			
TSW	✓				
GKW				✓	
KPRPSK	✓	✓	✓		
KPS08	✓	✓	✓		
KPSIX	✓	✓	✓		
KRX	✓	✓	✓		
KWPZ	✓	✓	✓	✓	
RUPZ	✓	✓	✓	✓	
SFXP	✓	✓	✓	✓	
SMHN	✓		✓		
SMKHN	✓		✓		
SMKCHN	✓		✓		
MOLLY				✓	
DuoXpand	✓	✓	✓		
HybridPower 10x90	✓	✓	✓		
KPK12	✓	✓	✓		
KPRFAST	✓	✓	✓		
KPRPK	✓	✓	✓		
KPS6HR	✓	✓	✓		
SFXK	✓	✓	✓	✓	
RUC	✓		✓	✓	
SFXC	✓	✓	✓	✓	
WXUNI	✓	✓	✓		
MHS-04032				✓	
PXUNI	✓	✓	✓		
RUL	✓		✓	✓	
SFXL	✓	✓	✓	✓	
HOXUNI	✓	✓	✓		
HX-12	✓	✓	✓		
RUO	✓	✓	✓		
SFXO	✓	✓	✓	✓	
FIXTAINER DUOPOWER	✓	✓	✓	✓	
RED BOX DUOPOWER	✓	✓	✓	✓	



# Anchors



**LEKP**

Zn



**BPBC**

Zn



**BPBTS**

Zn



**CLSS**

Zn



**FBRAR**

Zn

PA



**FBRB**

Zn



**KRW**

Zn



**FBN**

Zn



**LSI**

Zn



**BPBTS**

Zn



**RBNB880**

Zn

PA



**SMM**

Zn



**FBRX**

Zn



**FPX**

Zn



**KOBETH-M8**

Zn



**KOBETH-M10**

Zn



**TSW**

Zn

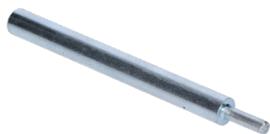

**OTSW**

Zn



**CLS**

Zn



**CLS8**

Zn



**CLSH**

Zn



**WB6-63045**

Zn



**FBS**

Zn



**WBSW**

Zn



**WDBGW**

Zn



**WDBGZ**

Zn



**FBRGA**

Zn



**FBRGC**

Zn



**KOBETK-M8**



**KOBETK-M10**

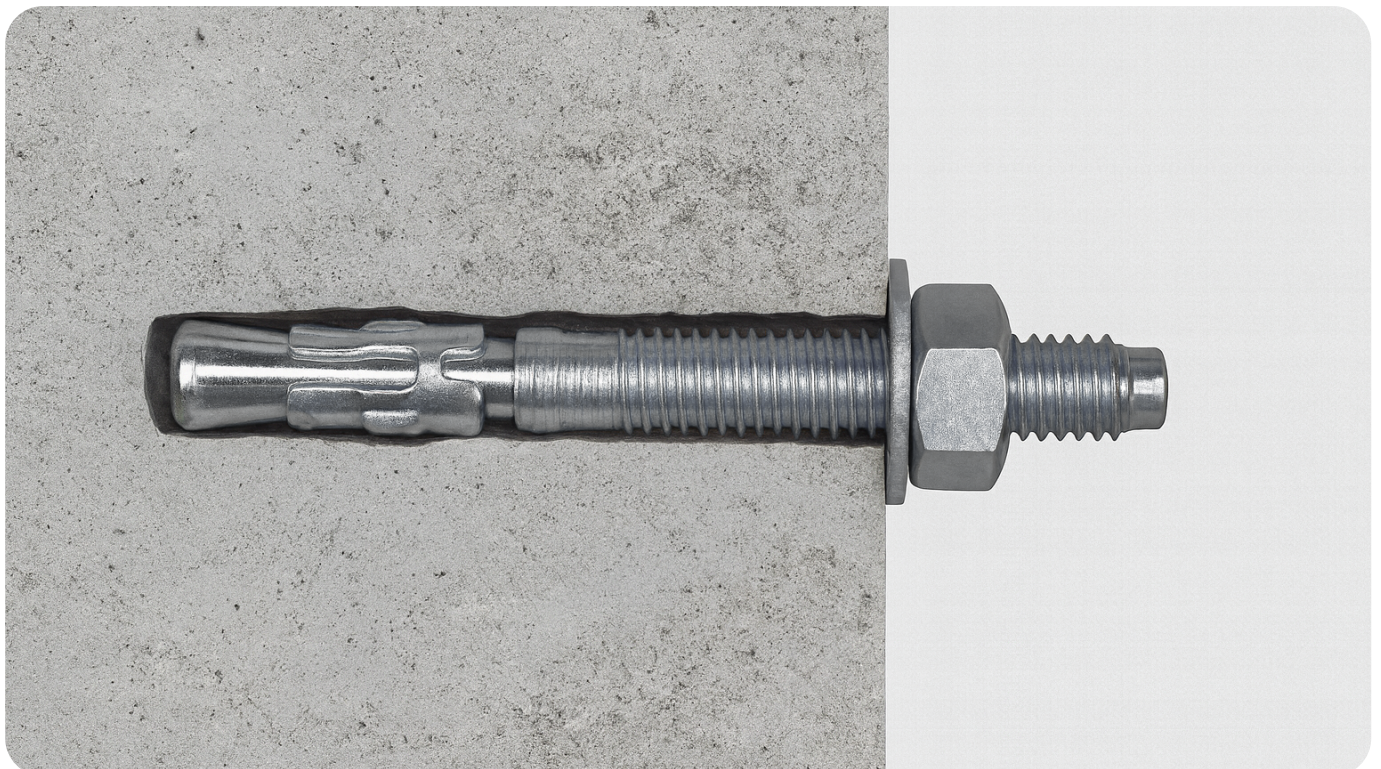



# self-tapping screws



**KMH**

Zn



**DIN7504K**

Zn



**DIN7504K-NO5**

Zn



**DIN7504N**

Zn



**DIN7504O**

Zn PA



**CTO**

Zn



**GS8**

Zn



**GT8**

Zn



**KMTEX**

PH Zn



**KSGD**

PH



**KSGM**

PH



**KSSG**

PH



**KMWHT**

Zn



**STKP**

Zn



**STKT**

Zn



**TURBO**

Zn



**TURBOA**

Zn



**UMN**

PH



**WDBLG**

Zn



**WHPS**

Zn



**WHWS**

Zn



**WKCP**

Zn



**WKCS**

Zn



**WPCV**

Zn



**WPF**

PH



**WPX**

Zn



**WR7016**

Zn RAL7016



**WSDST**

Zn



**WSPC**

Zn



**WSPCV**

Zn



**DIN571**

Zn



**FARMAR**

Zn





# self-tapping screws



**lustrHAK**

Zn



**obrtlik**

Zn



**OCKO**

Zn



**vitrHAK**

Zn



**ROSH**

PLASTIC



**SOLAREPDM**

EPDM



**FixTrainer FPF CTP**







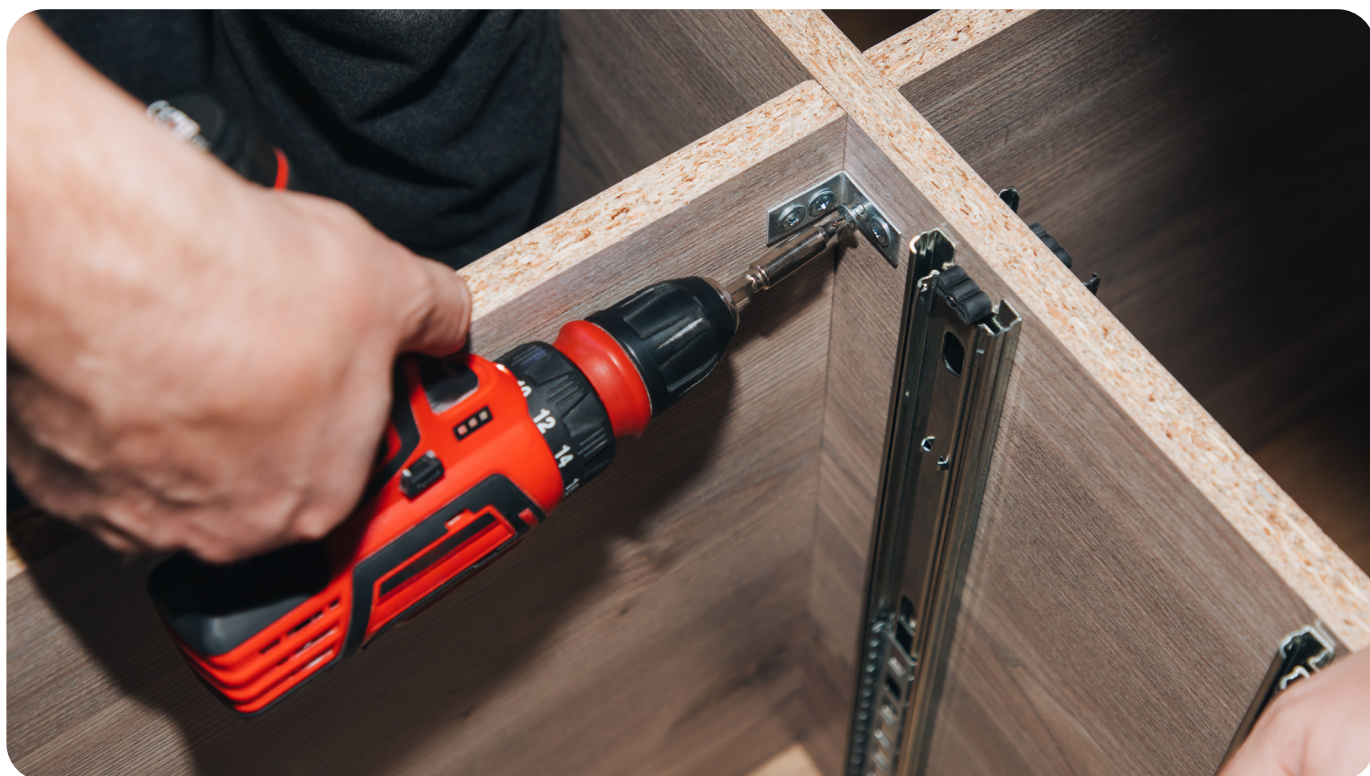

Zn



**FixTrainer FPF II TX**

Zn



Master	Concrete 	Aerated concrete 	Brick 	Plasterboard 	Sheet 	Metal 	Plastic 	Wood 
CLSS	✓							
CTO								✓
DIN7504N					✓			
DIN7504O					✓	✓		
GS8	✓							
GT8	✓							
KMH								✓
KMTEX					✓	✓		
KMWHT								✓
KSGD				✓				
KSGM				✓				
KSSG				✓				
STKP								✓
STKT	✓							✓
TURBO		✓	✓					
TURBOA		✓	✓					
UMN				✓				
WDBLG	✓							
WHPS								✓
WHWS								✓
WKCP								✓
WKCS								✓
WPCV					✓		✓	
WPF					✓	✓		
WPX					✓	✓		
WR7016					✓	✓		
WSDST					✓	✓		
WSPC					✓			
WSPCV					✓		✓	
DIN571								✓
DIN7504K					✓	✓		
DIN7504K-No5					✓	✓		
FARMAR					✓	✓		
FBS	✓							
lustrHAK								✓
obrtlik								✓
OCKO								✓
vitHAK								✓
FixTrainer FPF CTP								✓
FixTrainer FPF II TX								✓



# Screw and nut caps and leveling feet



**ZMSANTHRACITE**

PLASTIC RAL7016

KEY - 10 | 13 | 17 | 19 | 24



**ZMSWHITE**

PLASTIC RAL9010

KEY - 8 | 10 | 13 | 17 | 19 | 22



**ZMSBLACK**

PLASTIC RAL9005

KEY - 8 | 13 | 17 | 19 | 22 | 24  
27 | 30 | 36



**ZMSBROWN**

PLASTIC RAL8028

KEY - 10 | 13 | 17 | 19



**ZMSGRAY**

PLASTIC RAL7040

KEY - 8 | 13 | 17 | 19 | 22



**ZMSP**

PLASTIC

KEY - 24 | 27 | 30 | 36



**ZMSP16**

PLASTIC

KEY - 24



**ZSR1**

PLASTIC

M8 | M10



**ZSR3**

PLASTIC

M8 | M10



**ZSR4**

PLASTIC

M10



**ZSR5**

PLASTIC

M8



**ZSR6**

PLASTIC

M12



**ZSR7**

PLASTIC

M6 | M8



**ZGK**

PLASTIC

M8 | M10



**ZGM**

PLASTIC

M8 | M10



**ZGO**

PLASTIC

M8 | M10



**ZGO253**

PLASTIC

M8 | M10



**ZPOK**

PA

M6 | M8 | M10 | M12



**ZPOM**

PA

M6 | M8 | M10 | M12



**ZPOP**

PA

M5 | M6 | M8

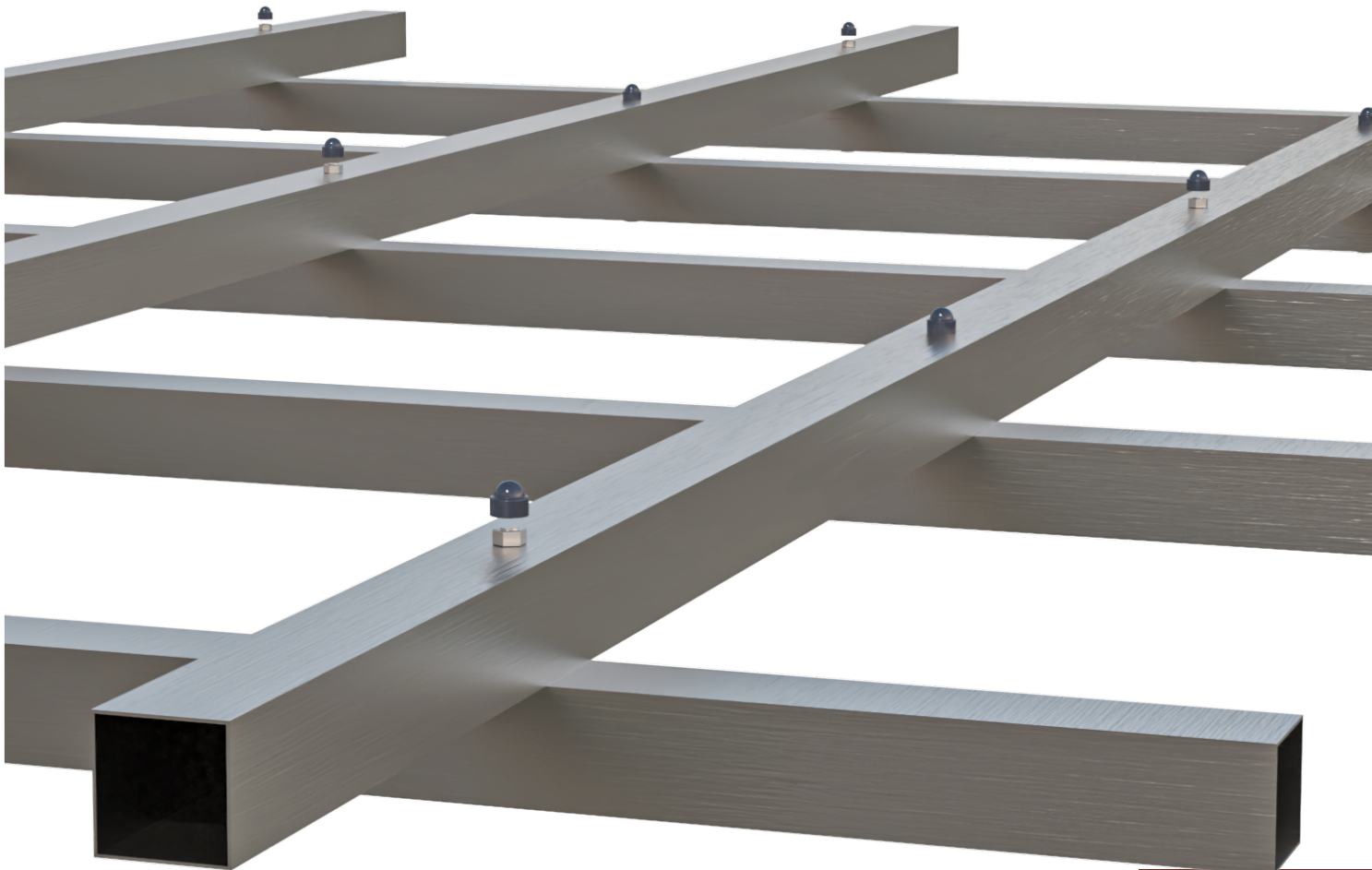
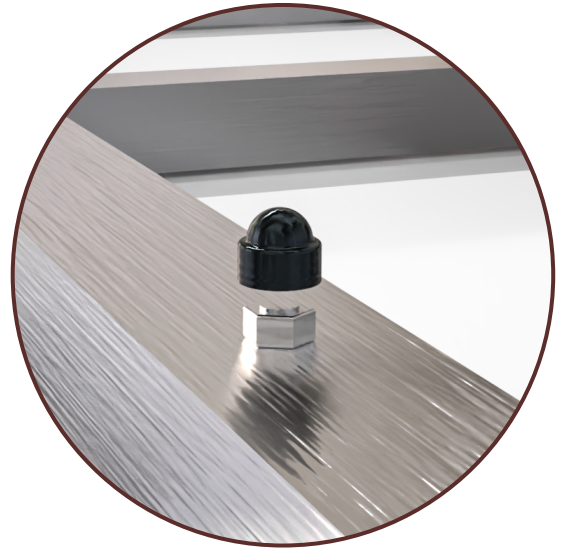



# Metric screws & threaded rods



**DIN933**

Zn



**912MX**

Zn



**603MX**

Zn



**931MX**

Zn



**DIN580**

Zn



**E-SK4**

Zn



**ZTX1**

Zn



**ZTX2**

Zn

## OTHERS



**NSV**

ALLOY



**hsw4**

AISI304



**NSV-P**

Zn





DIN934M

Zn



DIN985M

Zn RUBBER



DIN1587M

Zn



DIN315M

Zn



DIN439M

Zn



DIN582M

Zn



DIN6334M

Zn



DIN6923M

Zn



KMnP

Zn



MNM

Zn



MVK

Zn



MZB

Zn



MZBD

Zn



MZG

Zn



MZGD

Zn



S-M-ZI

Zn



SPREDSERT

BRASS



steck

Zn



# Rivets



**TRN**

ALU

STEEL



**TRNO**

STEEL



**TRN-VH**

ALU

STEEL



**TRN-ZH**

ALU

STEEL



**TRN-RAL7016**

ALU

STEEL



**TRN-RAL9005**

ALU

STEEL



**TRN-RAL8019**

ALU

STEEL



**TRN410-RAL7043**

ALU

STEEL



**NMO**

Zn



**FH-KB**

Zn



**RH-KB**

Zn



**FH-FHB**

Zn



**FH-KBC**

Zn



**FH-RB/AL**

ALU



**FH-SHB**

Zn



**RH-FHB**

Zn



**RH-KBC**

Zn



**RH-RB/AL**

ALU



**RH-SHB**

Zn



**SALI-KLNIT1**



**SALI-KLNIT2**



**SALI-KLNIT3**



**KLNIT1**



**KLNIT-BM-85**



**KLNIT-BM-160**



**KLNIT-S**



**KLNIT-TR-308**



**KLNIT-TR-312**



**BLIND**

Zn



**BGS-PNEUMANIT**



**G01354**





# Washers



DIN125

Zn



DIN125B

RAW



DIN9021

Zn



DIN9022

Zn



DIN440

Zn



DIN6798

Zn



DIN7980

Zn



BULLDOG

Zn

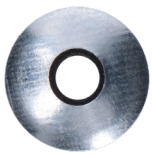

EPDM

Zn

RUBBER



KPZV

RAW



PODNKL

Ni



PWKSC

Zn

## COMBINATION SCREWS



VRUTM

Zn

## NAILS



DX-ANG

Zn



**KOBET35X25**

Zn



**KOBET35X25L**

Zn

PA



**KOBET35X35.9005**

Zn



**KOBET35x35.zn**

Zn



**KOBET38X25**

Zn

PA



**KOBET44X26**

Zn



**KOBET50X25**

Zn

PA



**Kobet 12Zn**

Zn



**Kobet 30Zn**

Zn



**KOBET L35**

RAW



**KOBET L40**

RAW

PA



**KOBET M12**

Zn

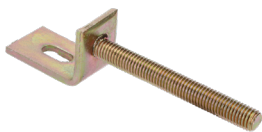

**Kobet M12L**

Zn



**KOBET P**

RAW



**KOBET U12**

RAW



**KOBET V**

RAW



**Kobet V2**

RAW



**Kobet-J**

RAW



# Chemical anchors



**BO-POL300**



**BO-POL400**



**BO-VIN300V2**



**BO-VIN400-PLUS**



**BO-VIN400-W**



**BO-VIN400V2**



**DB-POL-S**



**FIS EM PLUS 390 S**



**FIS V PLUS 360 S**



**FIS V PLUS 360 S HS**



**FIS VL 150 C**



**FIS VL 410 C**



**FIS VL 300ML T**



**FIS VL 300ML T HS**



**RFIS V PLUS 360 HWK**



**FIS VL 410 HWK BOX**





**FIS PIS300**



**FIS PIS360**



**FIS PIS360K**



**PIS300-PRO**



**PIS300-PROFI**



**PIS400-P**



**PIS400-PROFI**



**G00665**



**G00667**



**BO-HR01**

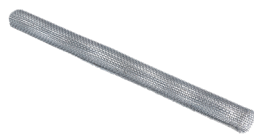

**BO-KS11**



**BO-PUM**



**FIS-HADICKA**



**FISCHER FILL&FIX**



**KEFKA-D**



# Accessories for mounting C-profiles



**DN-1**

Zn



**DN-2**

Zn



**DU-1**

Zn

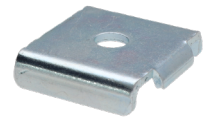

**DU-2**

Zn



**JN-1**

Zn



**JN-2**

Zn



**JN-3**

Zn



**JN-4**

Zn



**JN-5**

Zn



**JN-6**

Zn



**JN-7**

Zn

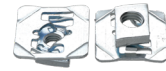

**JN-8**

Zn



**JN-9**

Zn



**JN-INOX1**

AISI304



**MU-1**

Zn

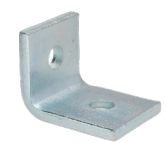

**MU-2**

Zn



**MU-3**

Zn



**MU-4**

Zn



**MU-5**

Zn



**MU-6**

Zn



**MU-7**

Zn



**MU-8**

Zn



**MU-9**

Zn



**MU-10**

Zn



**SN-UN11**

Zn



**SN-3**

Zn

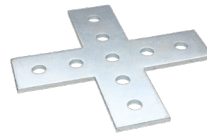

**SN-2**

Zn

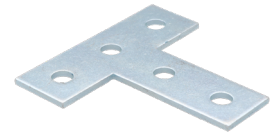

**SN-4**

Zn



**SN-5**

Zn



**SN-6**

Zn

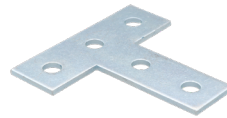

**SN-7**

Zn



**SN-8**

Zn



**ST-1**

Zn



**ST-2**

Zn



**ST-3**

Zn



**ST-4**

Zn



**NKS**

Zn



**SU-2**

Zn



**SU-UN11**

Zn



**SU-UN12**

Zn



# Ground screws

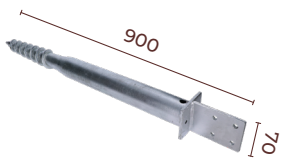

**ZSA 70X900**

HDG

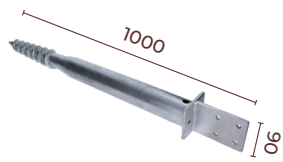

**ZSA 90X1000**

HDG

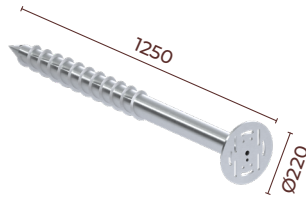

**ZSD**

HDG

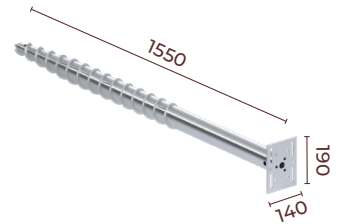

**ZSH1**

HDG

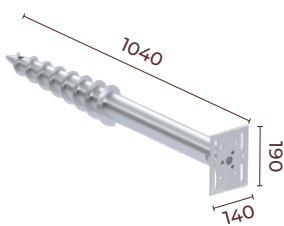

**ZSH2**

HDG

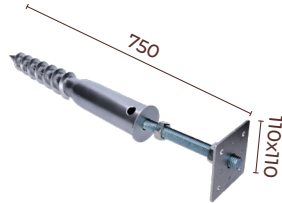

**ZSI 80X750**

Zn

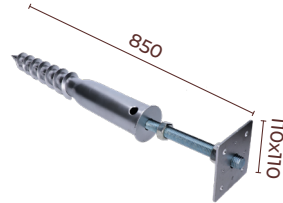

**ZSI 110X850**

Zn

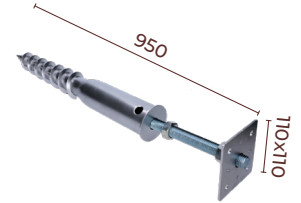

**ZSI 110X950**

Zn

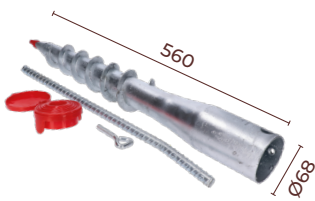

**ZSK 26-55x560mm**

HDG

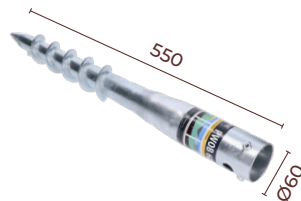

**ZSO 60X550**

HDG



**ZSO 68X580**

HDG



**ZSO 68X650**

HDG



**ZSO 68X800**

HDG



**ZSP 120X1000**

Zn



**ZSPZ 120X1000**

HDG

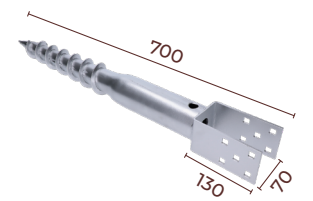

**ZSU 70X700**

Zn

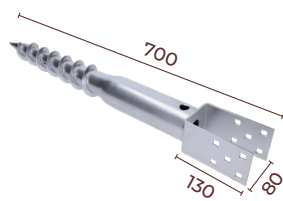

**ZSU 80X700**

Zn

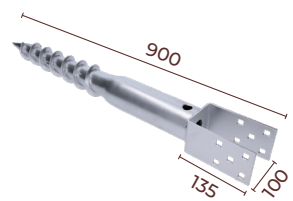

**ZSU 100X900**

Zn

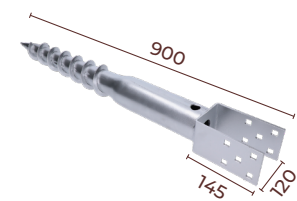

**ZSU 120X900**

Zn

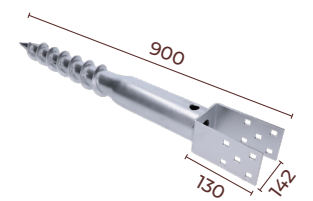

**ZSU 140X900**

Zn

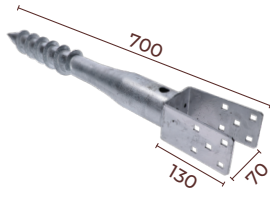

**ZSUZ 70X70**

HDG

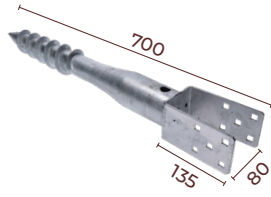

**ZSUZ 80X700**

HDG

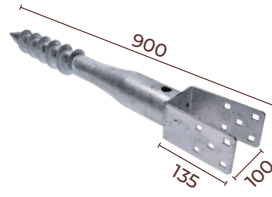

**ZSUZ 100X900**

HDG

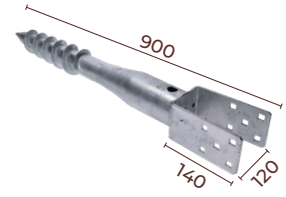

**ZSUZ 120X900**

HDG

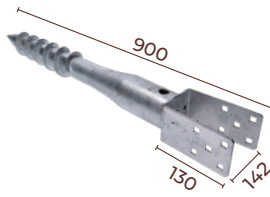

**ZSUZ 140X900**

HDG

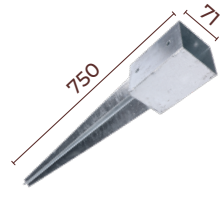

**DX-PSG 70/750**

HDG

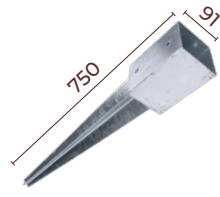

**DX-PSG 90/750**

HDG

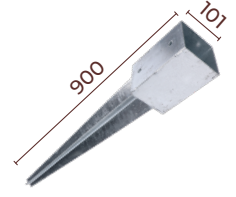

**DX-PSG 100/900**

HDG



**DX-WD**

RUBBER



**ZSO-N-1 ZSO-N-2**

Zn



**ZSO-N-3 ZSO-N-4**

Zn



**ZST**

Zn





# Wood connectors



**AL-PL**

ALU



**DX-KK**

Zn



**DX-KRD**

Zn



**DX-KSO**

Zn



**DX-KW**

Zn



**DX-OSK146**

RAW

RAL9005



**DX-KP1C**

RAW

RAL9005



**DX-KPK**

Zn



**DX-KPL**

Zn



**KMPR**

Zn



**DX-NA**

Zn



**DX-NAD**

RAW

RAL9005



**DX-TM**

Zn





**DX-LP**

Zn



**DX-LW**

Zn



**E1-PLM10**

AISI304



**E1-PLM12**

AISI304



**DH110X110**

HDG

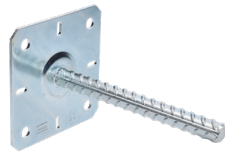

**DX-PPS**

Zn



**DX-PS**

HDG / Zn



**DX-PS84L**

HDG



**DX-PSC**

Zn



**DX-PSK70**

Zn



**DX-PSOZ**

HDG



**PP110X110**

Zn



**SNH-80**

Zn



**SNH-100**

Zn

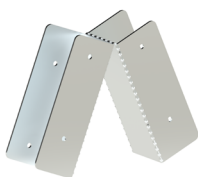

**OSP-80X80-1**  
**OSP-100X100-1**

Zn



**OSP-80X80-2**  
**OSP-100X100-2**

Zn



**OSP-80X80-3**  
**OSP-100X100-3**

Zn

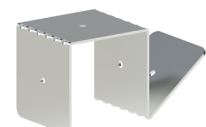

**OSP-80X80-4**  
**OSP-100X100-4**

Zn



# Decorative rivets, nails, screws, nuts



**KKN**

RAW



**KKN13**

RAW



**KKN16**

RAW



**KKN17**

RAW



**KKN18**

RAW



**KKN19**

RAW



**KKN21**

RAW



**KKN25**

RAW



**KKN25P**

RAW



**KNN15**

RAW



**KNN18**

RAW

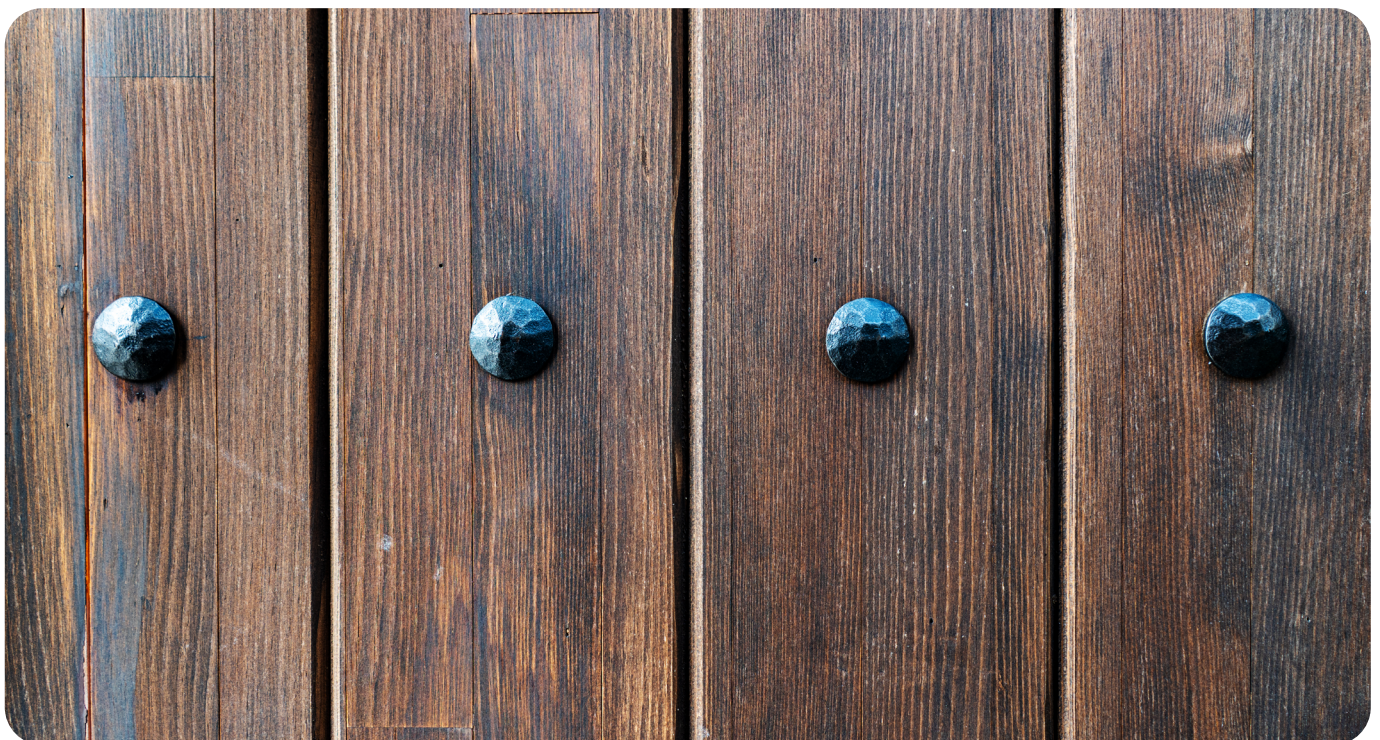



**KKO15**

RAW



**KKO20**

RAW



**KKO25**

RAW



**KKO30**

RAW



**KOK8**

RAW



**KOK14**

RAW



**KOK14A**

RAW



**KOK17**

RAW



**KOK18A**

RAW



**KOK20A**

RAW



**KOK22**

RAW



**KOK22A**

RAW



**KOK24**

RAW



**KOK27A**

RAW



**KOK28A**

RAW



**KOK30**

RAW

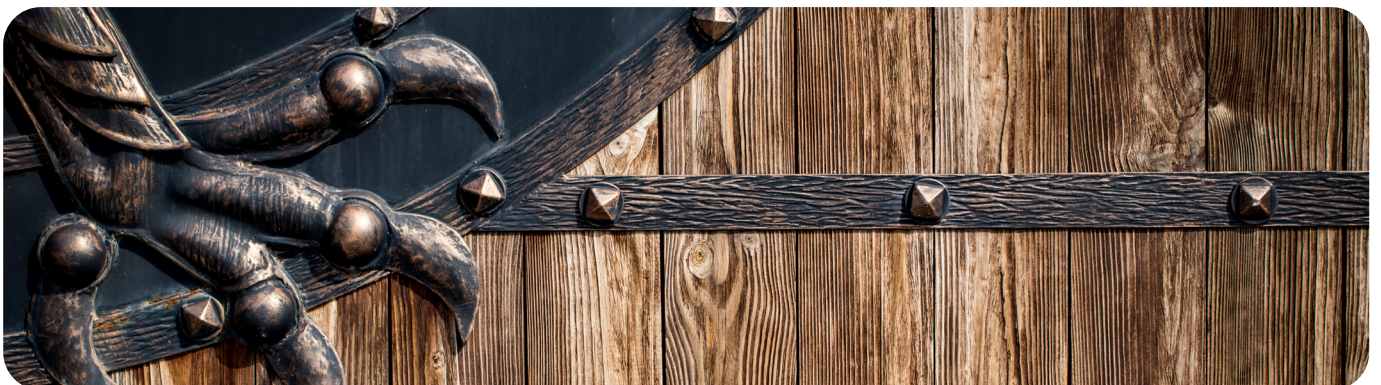



# Welding wire

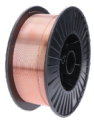

**DZ06/01**

G3Si1/SG2

Ø 0.6 mm | 1 kg

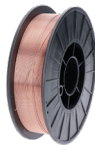

**DZ06/05**

G3Si1/SG2

Ø 0.6 mm | 5 kg

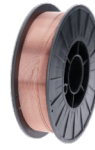

**DZ08/05**

G3Si1/SG2

Ø 0.8 mm | 5 kg

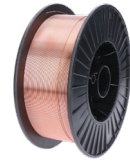

**DZ08/15**

G3Si1/SG2

Ø 0.8 mm | 15 kg

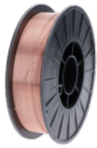

**DZ10/05**

G3Si1/SG2

Ø 1 mm | 5 kg

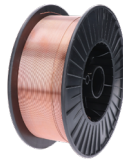

**DZ10**

G3Si1/SG2

Ø 1 mm | 15 kg



**DZ10/15K**

G3Si1/SG2

Ø 1 mm | 15 kg



**DZ12/15**

G3Si1/SG2

Ø 1.2 mm | 15 kg

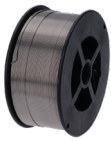

**EB8-MIG08/01**

AISI 308L

Ø 0.8 mm | 1 kg



**EB8-MIG08/05**

AISI 308L

Ø 0.8 mm | 5 kg

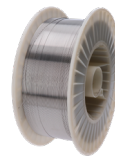

**EB8-MIG08**

AISI 308L

Ø 0.8 mm | 15 kg

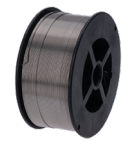

**EB8-MIG10/01**

AISI 308L

Ø 1mm | 1 kg



**EB8-MIG10/05**

AISI 308L

Ø 1 mm | 5 kg

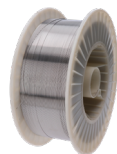

**EB8-MIG10**

AISI 308L

Ø 1.0 mm | 15 kg



**E71T-GS**

FLUX core

Ø 0.8 mm | 1 kg

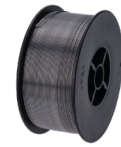

**E71T-GS-0.9**

FLUX core

Ø 0.9 mm | 1 kg



**E6013-1kg**

E6013

Ø 2.5 x 350 mm | 1 kg



**E6013-2.5kg**

E6013

Ø 2.5 x 350 mm | 2.5 kg



**E6013-5kg**

E6013

Ø 2.5 x 350 mm | 5 kg



**EB2-TIG16**

**AISI 316L**  
Ø 1.6 mm | 5 kg



**EB2-TIG20**

**AISI 316L**  
Ø 2 mm | 5 kg



**EB8-TIG16**

**AISI 308L**  
Ø 1.6 mm | 5 kg



**EB8-TIG20**

**AISI 308L**  
Ø 2 mm | 5 kg



**ADZI**

**AISI 316L**  
adapter

**ACCESSORIES**



**ZH2**



**ZH4**



**R007**



**ZK1**



**S500A**



**BGS-507**



**FM1-L**



**MWGC1-200F2**

